

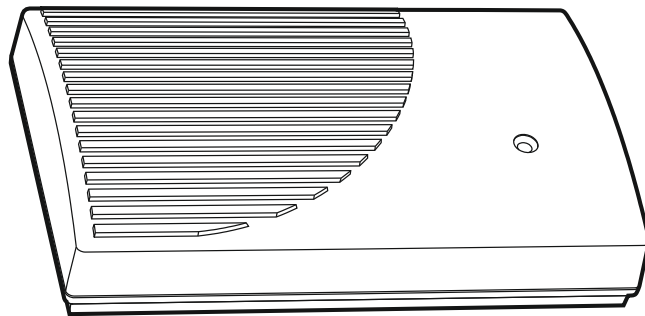

RK-1K / RK-2K / RK-4K / RK-4K SMA

Radio remote controller



Firmware version 1.00

rk-14k_en 11/20

SATEL sp. z o.o. • ul. Budowlanych 66 • 80-298 Gdańsk • POLAND
tel. +48 58 320 94 00
www.satel.eu

IMPORTANT

The device should be installed by qualified personnel.

Prior to installation, please read carefully this manual.

Changes, modifications or repairs not authorized by the manufacturer shall void your rights under the warranty.

The rating plate of the device is located on the enclosure base.

SATEL aims to continually improve the quality of its products, which may result in changes in their technical specifications and software. Current information about the changes being introduced is available on our website.

Please visit us at:
<https://support.satel.eu>

**Hereby, SATEL sp. z o.o. declares that the radio equipment type RK-1K / RK-2K / RK-4K / RK-4K SMA is in compliance with Directive 2014/53/EU. The full text of the EU declaration of conformity is available at the following internet address:
www.satel.eu/ce**

The following symbols may be used in this manual:



- note,



- caution.

CONTENTS

1	Features	2
2	Electronics board.....	2
3	Keyfobs	4
3.1	Keyfob battery replacement	4
4	Installation	4
4.1	Preparing the cabling	4
4.2	Installation of enclosure.....	5
4.3	Connecting the wires.....	5
4.4	Connecting the power supply and starting the controller.....	5
4.5	Connecting external antenna [RK-4K SMA]	6
5	Configuring	6
5.1	RK Soft program.....	6
5.1.1	Menu bar	6
5.1.2	Establishing connection between the program and the controller.....	8
5.1.3	Settings.....	8
5.1.4	Keyfob list	9
5.1.4.1	Adding a keyfob	10
5.1.4.2	Finding keyfobs on the list.....	13
5.1.4.3	Removing a keyfob	13
5.1.4.4	Importing keyfobs from a file	13
5.1.4.5	Copying keyfob data to another controller.....	13
5.2	Pins and buttons on the electronics board	13
5.2.1	Setting the operating mode of a relay output	13
5.2.2	Programming the relay output cut-off time.....	14
5.2.3	Adding a keyfob.....	14
5.2.4	Removing a keyfob.....	14
6	Restoring factory default settings	15
7	Specifications	15
8	Manual update history	16

The RK-1K / RK-2K / RK-4K / RK-4K SMA controller allows you to control devices connected to relay outputs by means of keyfobs. The controller may be used for the remote control of parking barriers, gates, roller shutters, etc. The controller is provided with inputs and an output designed specifically to work with alarm control panels which means it can also be used for the remote control of alarm systems.

1 Features

- Relay outputs (channels):
 - 1 [RK-1K],
 - 2 [RK-2K],
 - 4 [RK-4K / RK-4K SMA].
- Ability to register up to 1024 keyfobs.
- Option to configure from a computer with RK Soft program installed.
- 2 OC type outputs:
 - indication of low keyfob battery,
 - indication of arming / disarming / alarm clearing in the alarm system.
- 2 inputs to supervise the state of the alarm system:
 - armed mode information,
 - alarm information.
- RS 232 (TTL) port used for communication with a computer.
- LED indicator.
- Tamper switch activated by cover removal.
- Can be supplied by a direct or alternating current.

2 Electronics board

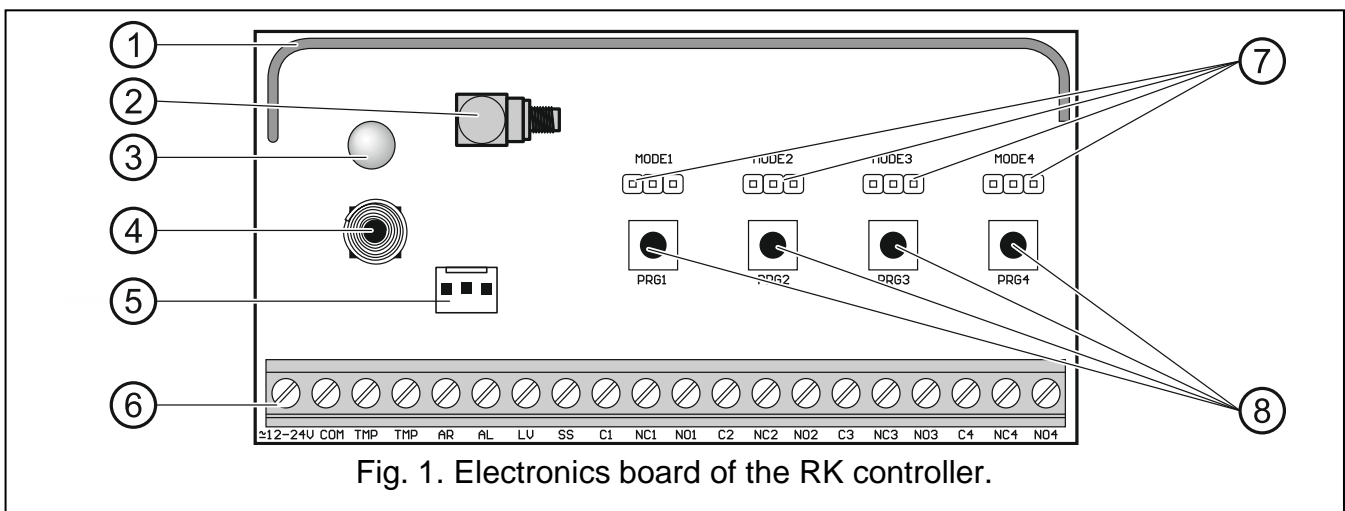

Fig. 1. Electronics board of the RK controller.

- ① antenna.
- ② SMA connector for external antenna [RK-4K SMA].
- ③ bicolor LED indicator:
 - ON in green – power OK,
 - ON in red – transmission has been received from keyfob,

flashing red – transmission has been received from keyfob with low battery.

- ④ tamper switch.
- ⑤ RS 232 port (TTL standard).
- ⑥ terminals (see: “Terminals”).
- ⑦ MODE pins. To be used for setting the operating mode of relay outputs. The digit stands for the number of the relay output (see: “Setting the operating mode of a relay output”).
- ⑧ PRG buttons. Allow you to add / remove keyfobs and set the cut-off time of relay outputs. The digit stands for the number of the relay output. The PRG1 button can be used to restore the factory default settings.



The RK-1K controller has no MODE 2 / MODE 3 / MODE 4 pins and no PRG2 / PRG3 / PRG4 buttons.

The RK-2K controller has no MODE3 / MODE4 pins and no PRG3 / PRG4 buttons.

Terminals

- ≈ 12-24V** - power input (12...24 VDC / 24 VAC).
- COM** - common ground.
- TMP** - NC type tamper output (opening the tamper switch will open the output). You can connect the TMP output to the appropriately programmed zone of the alarm control panel.
- AR** - input supervising the armed status in the alarm system. The input is activated after applying the common ground. Connect the AR input to the control panel OC type output indicating the armed status.
- AL** - input supervising the alarm status in the alarm system. The input is activated after applying the common ground. Connect the AL input to the control panel OC type output indicating the alarm to be cleared.
- LV** - output indicating low battery in the keyfob. The output will be turned on after receiving a transmission from the keyfob with low battery. The output will be turned off after receiving a transmission from the keyfob whose battery is OK. OC type output (shorted to common ground when active). You can connect e.g. a LED to the LV output, or you can connect the output to an appropriately programmed zone of the alarm control panel.
- SS** - output indicating arming / disarming / alarm clearing in the alarm system. The indication will be triggered if the AR and/or AL input status is changed within 4 seconds of receiving a transmission from the keyfob. The indication is provided in the form of pulses of 0.16 second duration:
 - 1 pulse – arming,
 - 2 pulses – disarming,
 - 4 pulses – disarming and/or alarm clearing.
 OC type output (shorted to common ground when active). You can connect e.g. a siren to the SS output.
- C1...C4** - relay output common contact.
- NC1...NC4** - relay output normally closed contact.
- NO1...NO4** - relay output normally open contact.



The RK-1K controller has no terminals of relay outputs 2, 3 and 4.

The RK-2K controller has no terminals of relay outputs 3 and 4.

3 Keyfobs

The controller supports the following SATEL 433 MHz keyfobs:

MPT-350 – 5-button keyfob,

MPT-300 – 5-button keyfob,

T-4 – 4-button keyfob,

T-2 – 2-button keyfob,

T-1 – 1-button keyfob,

P-4 – 4-button keyfob,

P-2 – 2-button keyfob.

Transmissions from the keyfobs are encrypted using code-hopping.

The controller is delivered with two keyfobs. Depending on the controller's model, the keyfobs are:

RK-1K – T-1,

RK-2K – T-2,

RK-4K / RK-4K SMA – T-4.

3.1 Keyfob battery replacement

The battery life depends on how the keyfob is used. The more frequently the buttons are pressed, the faster the battery drains. When the controller indicates that the battery is running low (LED; LV output), replace the battery as soon as possible.



There is a danger of battery explosion when using a different battery than recommended by the manufacturer, or handling the battery improperly.

Be particularly careful during installation and replacement of the battery. The manufacturer is not liable for the consequences of incorrect installation of the battery.

The used batteries must not be discarded, but should be disposed of in accordance with the existing rules for environment protection.

4 Installation



Disconnect power before making any electrical connections.

The controller should be installed indoors, in spaces with normal air humidity. When selecting the installation place, take into consideration that thick walls, metal partitions, etc. will reduce the radio signal range. It is recommended that the controller be mounted high above the floor. This will allow you to get a better range of radio communication and avoid the risk of the controller being accidentally covered by people moving around the premises. Installing the device in close vicinity of electrical systems is not recommended, since it can affect the range of radio signal.

4.1 Preparing the cabling

Prepare the cables you will use to connect the controller to other devices and run them to the controller's installation location. The cabling should not be run in close vicinity of low-voltage electrical system wires, and especially of power cables for high-power equipment (such as electric motors).

We recommend using an unshielded non-twisted cable.

4.2 Installation of enclosure

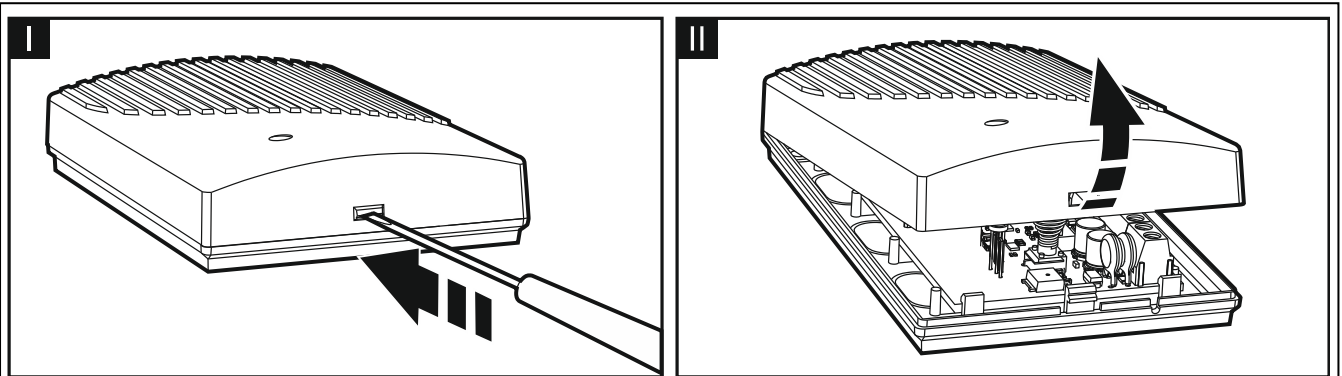

Fig. 2. Opening the enclosure.

The controllers are sold complete with an enclosure.

1. Remove the cover (Fig. 2).
2. Remove the electronics board.
3. Place the enclosure base against the wall and mark location of the mounting holes.
4. Drill holes for wall plugs (anchors) in the wall.
5. Make the cable entry opening at the base. The prepared opening should be wider than 10 mm in diameter and free of any sharp edges.
6. Run the wires inside the cover (power cables, cables connecting the controller to other devices).
7. Using wall plugs and screws, secure the enclosure base to the wall. Proper wall plugs must be selected for the type of mounting surface (different for concrete or brick wall, different for plaster wall, etc.).
8. Fasten the electronics board in the enclosure.

4.3 Connecting the wires



Protect the wiring against contact with sharp edges or else they can damage the insulation of cables.

1. Connect the relay output terminals to the device(s) that are to be controlled by the controller.
2. If the controller is to work with an alarm system, connect the terminals of the supervising inputs to the outputs of the alarm control panel.
3. You can connect the tamper output to an appropriately programmed alarm control panel input.
4. You can connect a LED to the output indicating low keyfob battery, or you can connect the output to an appropriately programmed alarm control panel input.
5. You can connect a siren to the output indicating alarm.

4.4 Connecting the power supply and starting the controller

1. Connect the power cables to the +12-24V and COM terminals (use flexible conductors with a cross-section of 0.75-1.5 mm²). The controller may be powered from a power supply unit or the control panel.
2. Replace the cover.



When closing the enclosure, make sure not to press any of the programming buttons with cables.

3. Turn the power on. The controller's LED indicator should come on in green.



After power-on of the controller the outputs are turned off.

4.5 Connecting external antenna [RK-4K SMA]

If the radio signal received from the keyfobs in the controller's future installation place is too weak, use the RK-4K SMA controller which offers the capability to connect an external antenna using an additional cable.

The antenna must have impedance of 50 Ω . Do not install the antenna in parallel to low-voltage electrical wires, since it can affect its performance. Do not place the antenna in the vicinity of metal objects, since it can adversely affect the range of radio signal received by the antenna.

The cable must have impedance of 50 Ω , minimal attenuation and be of high quality.

5 Configuring

You can configure the controller using:

- the RK Soft program,
- pins and buttons on the electronics board.

5.1 RK Soft program

The RK Soft program allows you to:

- configure most of the controller settings,
- manage keyfobs,
- run diagnostics on the controller,
- save controller settings and keyfob data to your computer,
- copy keyfob data from one controller to another.

You can download the program from www.satel.eu website. Required program version: 1.01 (or newer).

5.1.1 Menu bar

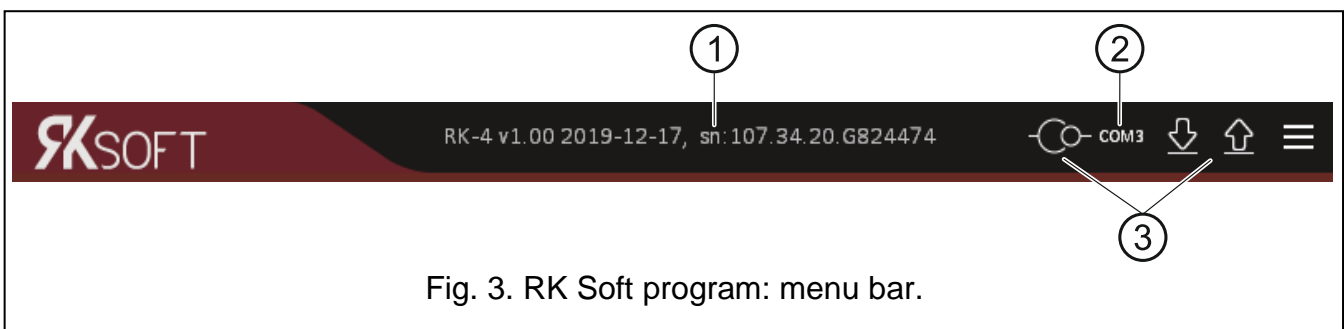







Fig. 3. RK Soft program: menu bar.

- ① controller type, firmware version, build date and serial number. Different font colors indicate:
white – communication with the controller in progress, data from device.
grey – no communication with the controller, data from file.
- ② computer port used for communication with the controller.

③ buttons:

-  – click to establish connection to the controller. The button is displayed when the program is not connected to the controller.
-  – click to end connection to the controller. The button is displayed when the program is connected to the controller.
-  – click to read data from the controller.
-  – click to write data to the controller.
-  – click to display additional menu:
 - Open** – click to open the controller data file.
 - Save** – click to write the controller data to file.
 - Connection** – click to open the “Connection” window.
 - Configuration** – click to open the “Configuration” window.
 - Language** – click to change the program language.
 - About** – click to display information about the version of the RK Soft program.

“Connection” window

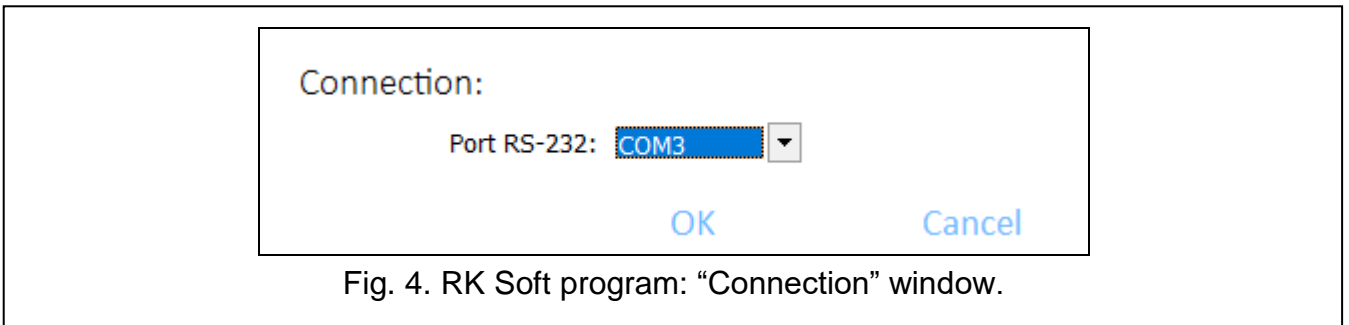

Fig. 4. RK Soft program: “Connection” window.

Port RS-232 – computer COM port to be used for communication with the controller.

OK – click to confirm the changes.

Cancel – click to close window without saving changes.

“Configuration” window

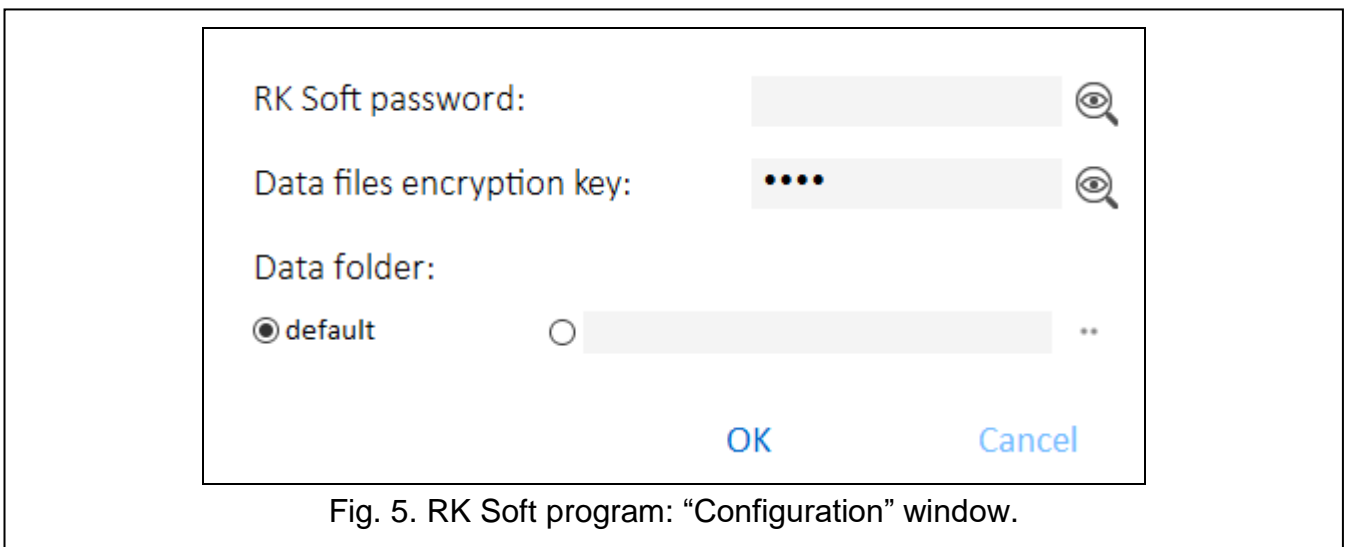



Fig. 5. RK Soft program: “Configuration” window.

RK Soft password – password protecting against unauthorized access to the program. If you decide to enter the password, a window will open and you will be asked for your

password on each start-up of the RK Soft program. If you leave the field blank, the program will not be password-protected. Click  to view the password.

Data files encryption key – if you want the files saved to disk to be additionally encrypted, enter the file encryption key. Opening the files in another RK Soft program without entering the valid key will be impossible. Click  to view the key.

Data folder – location of files with controller settings:



Default – files are saved to the default folder,

[empty field/location] – file location selected by the user. Click  to select the location for the controller data files.

OK – click to confirm the changes.

Cancel – click to close window without saving changes.

5.1.2 Establishing connection between the program and the controller

1. Connect the controller RS-232 (TTL) port with the computer port using the USB-RS converter offered by SATEL.
2. Run the RK Soft program.
3. Select the computer COM port to be used for communication with the controller (see ““Connection” window” p. 7).
4. Click  on the menu bar.
5. After connection is established, information about the controller and the  button will be displayed on the menu bar.

5.1.3 Settings

Name – name of the controller.

Comm. password – password protecting the connection to the controller. If you decide to enter the password, a window will open and you will be asked for your password each time you try to connect the RK Soft program to the controller. If you leave the field blank, the connection will not be password-protected. Click  to view the password.

Type – the operating mode of the relay output. You can set it using the pins on the electronics board (see: “Setting the operating mode of a relay output” p. 13).

Cut-off time – the cut-off time for the relay output working in the monostable mode. By default, the value is set to 5 seconds. You can program values ranging from 1 to 3600 seconds.

Disable programming using controller – if this option is enabled, changing the keyfob settings or the output cut-off times using the buttons on the controller will be impossible (you can still restore the factory default settings). This option is disabled by default.

Status

The controller’s input and output states will be indicated by the background color:

- green – input inactive / output disabled;
- red – input active / output enabled.

Reception – information about the transmission from the keyfob:

- grey – the controller receives no transmission,
- orange – the controller receives a transmission from the keyfob.

Last received keyfob transmission – information about the last keyfob transmission received by the controller, the keyfob’s position on the “Keyfob list”, the keyfob’s name and the button pressed on the keyfob. The information is displayed until a new transmission is received from another keyfob.

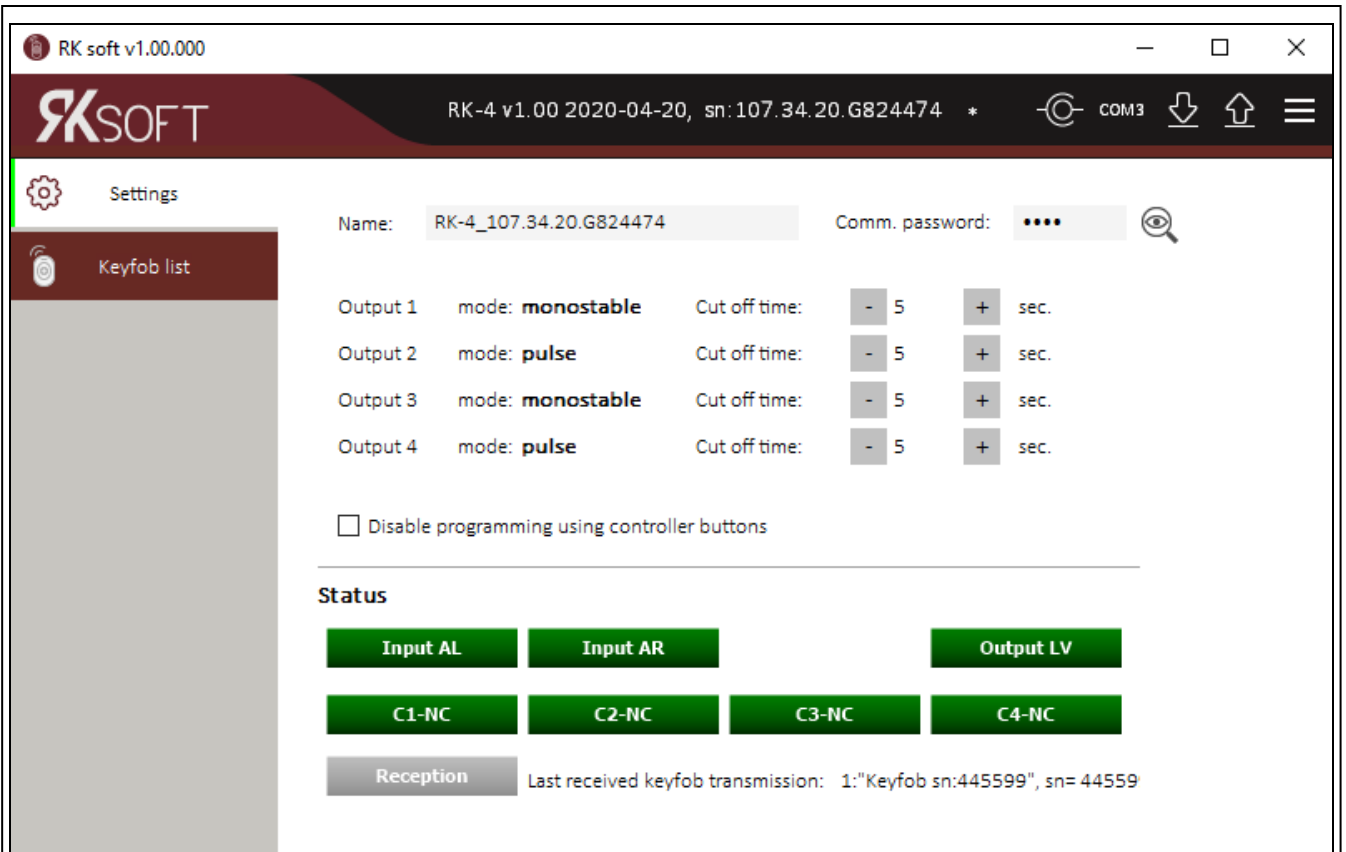

Fig. 6. RK Soft program: “Settings” tab.

5.1.4 Keyfob list

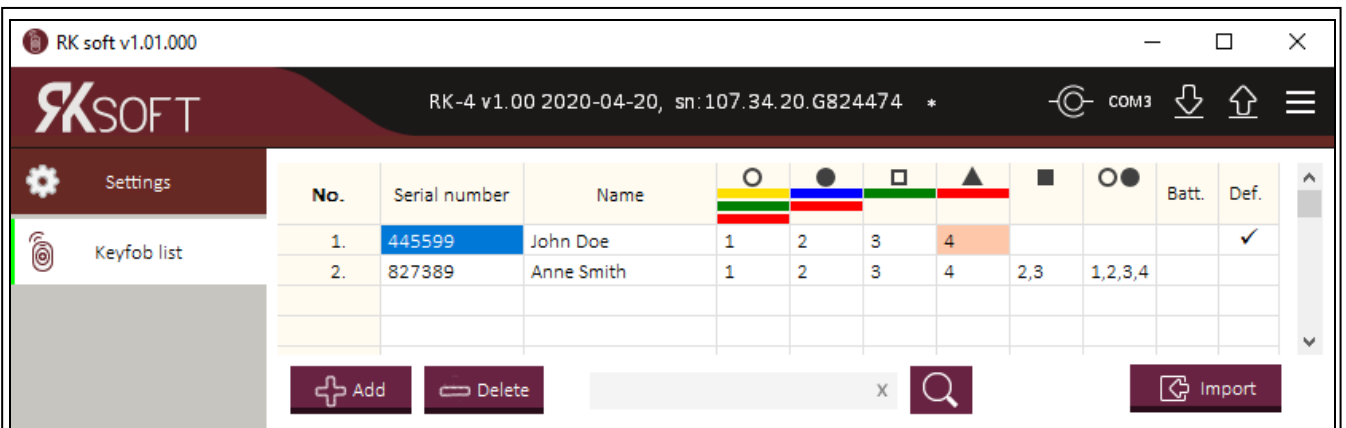

Fig. 7. RK Soft program: “Keyfob list” tab.

No. – keyfob item number. Click the column header to sort the keyfobs by order of their adding.

Serial number – keyfob serial number. Click the column header to sort the keyfobs by their serial number (ascending).

Name – individual keyfob name (up to 16 characters). You can enter a name that will help you to identify the keyfob. Click the column header to sort the keyfobs by their name (ascending).

Keyfob buttons – for each button (combination of buttons), you can enter the number of the output to be controlled by the button (combination of buttons). You can assign up to 4 outputs to one button (see fig. 7). The symbols correspond to the buttons on the MPT-300

and MPT-350 keyfobs. The colors in the top row (yellow to red) correspond to the buttons on the T-4 keyfobs. The colors in the middle row (green and red) correspond to the buttons on the T-2 keyfobs. The color red in the bottom row corresponds to the button on the T-1 keyfob. A field will change its highlight color after a button was pressed on the keyfob:

- orange (fig. 8) – button currently pressed,
- light orange (fig. 9) – button recently pressed. The field will remain highlighted until a new transmission is received from another keyfob.

No.	Serial number	Name								Batt.	Def.
1.	445599	John Doe	1	2	3	4					✓

Fig. 8. Information about which keyfob button is currently pressed.

No.	Serial number	Name								Batt.	Def.
1.	445599	John Doe	1	2	3	4					✓

Rys. 9. Information about which keyfob button was recently pressed.

Batt. – information about battery status.

[empty field] – battery OK,

– low battery.

Def. – if this option is enabled, the keyfob settings are copied for each new keyfob registered to the controller. This reduces the time required for configuration of the new keyfobs.

Add – click to add a new keyfob (see: “Adding a keyfob”).

Delete – click to remove a keyfob (see: “Removing a keyfob”).

– click to find a keyfob (see: “Finding keyfobs on the list”).

Import – click to import keyfobs from a file with SATEL radio controller data (see “Importing keyfobs from a file”).

5.1.4.1 Adding a keyfob

Reading the serial number during transmission

1. Click . The “Adding keyfobs” window will open (fig. 10).

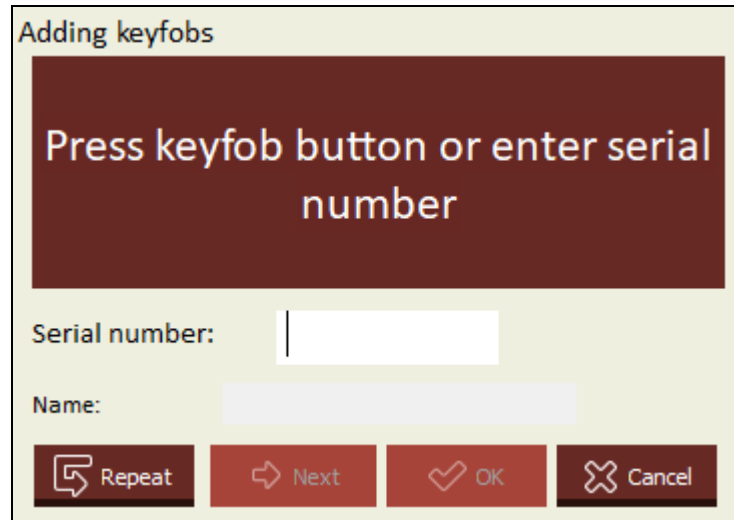



Fig. 10. "Adding keyfobs" window after opening.

2. Press a button on the keyfob you want to add. The keyfob's serial number will be displayed in the "Serial number" field (fig. 11). Make sure that the number matches the serial number of the keyfob you are adding (you will find it on the keyfob's bag). If the numbers match, proceed to the next step. If they do not match, it means that the controller received a transmission from another SATEL keyfob. In that case, click  and enter the keyfob's serial number in the "Serial number" field.

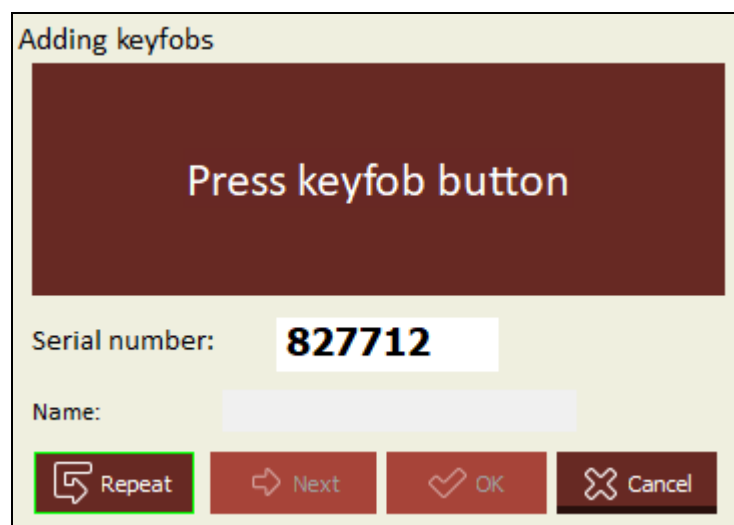

Fig. 11. "Adding keyfobs" window: the keyfob's serial number read during a transmission / entered by the user.

3. Press a button on the keyfob again. The program will inform you that the keyfob data were successfully read (fig. 12). The suggested keyfob name will be displayed in the "Name" field. You can change the name.

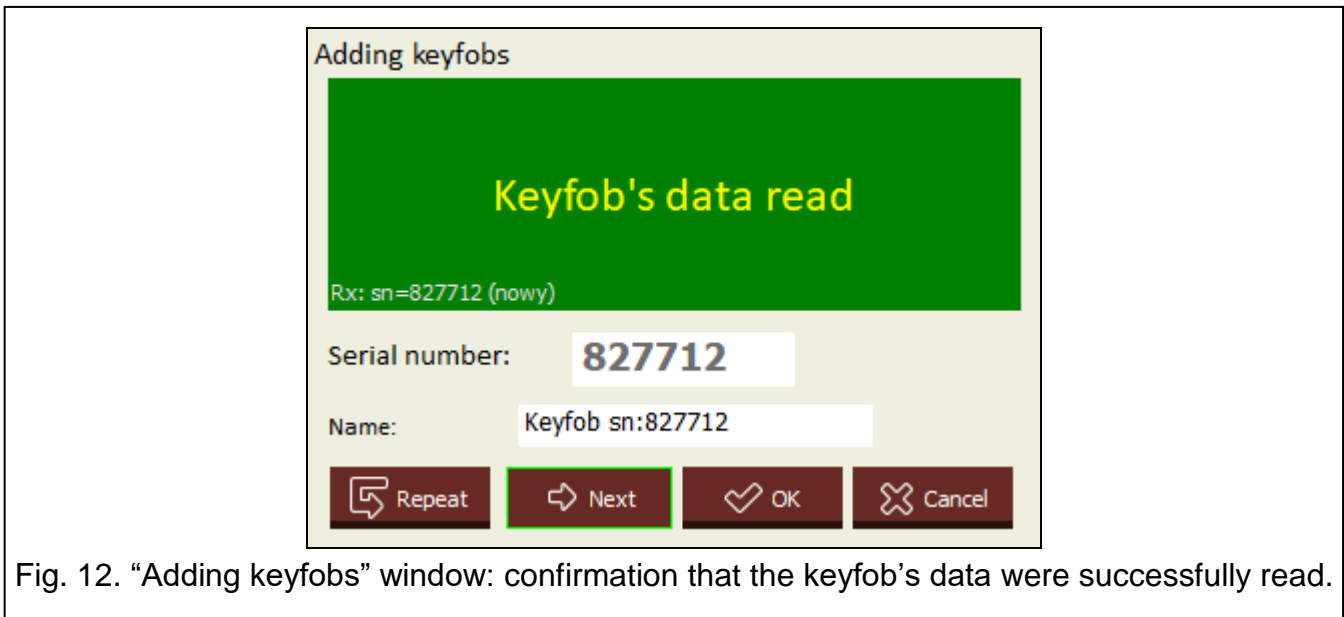

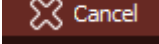



Fig. 12. "Adding keyfobs" window: confirmation that the keyfob's data were successfully read.

4. Click  to save the keyfob data. The "Adding keyfobs" window will close. The new keyfob will be displayed on the keyfob list.



If you want to add another keyfob right away, click  instead of .



You can stop the procedure at any time by clicking .

5. Specify, which of the relay outputs are to be controlled by the keyfob (see: "Assigning an output to keyfob button (combination of buttons)").
6. Click  to write changes to the controller.

Entering the serial number manually



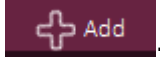

You can enter the serial number manually only when the program is not connected to the controller.

1. Click .
2. Enter the keyfob's serial number in the "Serial number" column.
3. Enter the keyfob's name in the "Name" column.
4. Specify, which of the relay outputs are to be controlled by the keyfob (see: "Assigning an output to keyfob button (combination of buttons)").
5. Establish connection between the program and the controller to which you want to copy the keyfob data (see: "Establishing connection between the program and the controller" p. 8).
6. Click  to write changes to the controller.
7. When the "Upload to module" window will open, click "Save".



Assigning an output to keyfob button (combination of buttons)

1. Click on the field corresponding to the button (combination of buttons).
2. Enter the number(s) of the relay output(s) that are to be controlled by the button and click ENTER (the program will automatically separate the relay output numbers with commas).

5.1.4.2 Finding keyfobs on the list

1. Click on the search bar and enter part of the keyfob's serial number or name.
2. Click . The field containing the requested data will be highlighted in blue.
3. Click  again if you want to find another keyfob whose serial number or name contains the sequence of characters you entered previously.

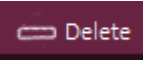
5.1.4.3 Removing a keyfob

1. Click on the keyfob you want to remove.
2. Click . The "Remove keyfob" window will open.
3. Click "Delete". The "Remove keyfob" window will close.
4. Click  to write changes to the controller.

5.1.4.4 Importing keyfobs from a file

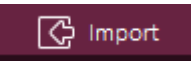
1. Click . The "Keyfob import" window will open.
2. Select the type of the data file (saved in the DLOAD10 or the RK Soft program) in the lower right corner of the window.
3. Indicate the location of the file with SATEL radio controller data.
4. Click "OK". The "Keyfob import" window will close.
5. Specify which relay outputs are to be controlled by the keyfobs imported from a file (see "Assigning an output to keyfob button (combination of buttons)").



Only the keyfob names and serial numbers are imported from a file by the program. Button settings are not copied. If the "Def." option is enabled for one of the keyfobs, its settings will be copied for all the keyfobs imported from a file.

6. Click  to write changes to the controller.

5.1.4.5 Copying keyfob data to another controller

1. Open the controller data file from which you want to copy the keyfob data.
2. Establish connection between the program and the controller to which you want to upload the keyfob data (see: "Establishing connection between the program and the controller" p. 8).
3. Do not read the controller data, but instead, click .
4. When the "Upload to module" window will open, click "Save".

5.2 Pins and buttons on the electronics board

Each relay output is assigned a button and a set of pins. Using the set of pins, you can specify the operating mode of the relay output. Using the buttons, you can:

- specify the relay output cut-off time,
- add a keyfob,
- remove a keyfob.

5.2.1 Setting the operating mode of a relay output

Below it is shown how to set the operating mode of the relay output 1. The remaining relay outputs should be handled in the same way.

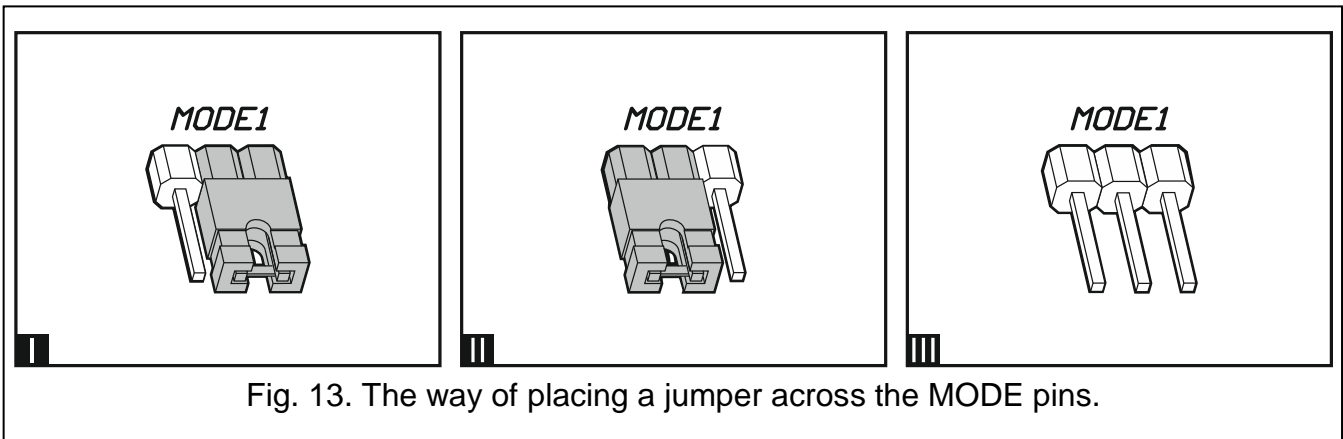

<p>MODE1</p>	<p>Pulse mode [jumper across pins on the right (Fig. 13-I)] – the relay output is turned on when the keyfob button is pressed (up to 30 seconds – then the keyfob stops transmitting to prevent the battery discharge).</p>
<p>MODE1</p>	<p>Monostable mode [jumper across pins on the left (Fig. 13-II)] – pressing the keyfob button turns on the relay output for a preset time.</p>
<p>MODE1</p>	<p>Bistable mode [jumper removed from pins (Fig. 13-III)] – each pressing the keyfob button changes the relay output status to the opposite one.</p>

Table 1.

5.2.2 Programming the relay output cut-off time

The relay output cut-off time should be programmed if the output works in the monostable mode and you want the time set to value other than the default (5 seconds).

1. Press twice the button designated with the number of the relay output for which you want to program the time. The LED will go off.

i *If you want to quit programming the time, press again the button designated with the number of the relay output.*

2. Press the keyfob button. The LED will start flashing green and red alternately.
3. Measure the time during which the relay output is to be turned on and press the keyfob button again. The LED will turn on in green.

5.2.3 Adding a keyfob

1. Press the button designated with the number of the relay output that is to be controlled by the keyfob. The LED will start flashing green.
2. Press the keyfob button that is to control the output. The LED will start flashing red.

i *If the LED will turn on in green, it means that no more keyfobs can be added or the keyfob is not supported.*

3. Press the same keyfob button again. The LED will turn on in green.

5.2.4 Removing a keyfob

A keyfob will be removed if it no longer controls any outputs.

1. Press the button designated with the number of the relay output controlled by the keyfob. The LED will start flashing green.
2. Press the keyfob button that controls the output. The LED will start flashing red.

3. Press the same controller button again. The LED will turn on in green. The keyfob button will no longer control the output.
4. Repeat the procedure for the remaining outputs controlled by the keyfob.

6 Restoring factory default settings

When restoring the factory default settings, you will delete all keyfobs.

1. Press and hold down the PRG1 button.
2. After about 3 seconds, when the LED flashes red once, release the button.
3. Press and hold down again the PRG1 button.
4. After about 3 seconds, when the LED starts flashing red, release the button.
5. When the LED stops flashing red and turns on in green, it means that the factory default settings of the controller have been restored.

7 Specifications

RK-1K / RK-2K / RK-4K / RK-4K SMA controller

Supply voltage:

direct current	12...24 VDC \pm 10%
alternating current	24 VAC \pm 10%

Standby current consumption

power supply 12 VDC	18 mA
power supply 24 VAC	32 mA

Maximum current consumption

power supply 12 VDC	
RK-1K	27 mA
RK-2K	37 mA
RK-4K / RK-4K SMA	58 mA
power supply 24 VAC	
RK-1K	36 mA
RK-2K	40 mA
RK-4K / RK-4K SMA	48 mA

Operating frequency band 433.05 ÷ 434.79 MHz

Relay output..... 1 A / 24 VDC/VAC

LV output 50 mA / 24 VDC/VAC

SS output 500 mA / 24 VDC/VAC

Operating temperature range..... -10°C...+55°C

Maximum humidity..... 93 \pm 3 %

Dimensions 118 x 72 x 24 mm

Weight

RK-1K	77 g
RK-2K	81 g
RK-4K	90 g
RK-4K SMA	92 g

T- 1 / T-2 / T-4 keyfob

Operating frequency band.....	433.05 ÷ 434.79 MHz
Radio communication range (in open area)	
RK-1K / RK-2K / RK-4K	350 m
RK-4K SMA (with external antenna)	500 m
Battery.....	23 A 12 V
Operating temperature range.....	-20°C...+55°C
Dimensions	35 x 70 x 15 mm
Weight.....	28 g

8 Manual update history

Manual version	Introduced changes
11/20	<ul style="list-style-type: none"> • Information on the required version of the RK Soft program has been added (p. 6). • Description of the "Import" button has been added (p. 10). • Description of importing keyfobs from a file has been added (p. 13).