

SC-2402 LCD Monitor 24"



Bezel Less Security Monitors Give Productivity For Multiple Monitor Workstation in Control Rooms

The SC-2402 is a 24-inch 3-sided bezel less security monitor specifically designed for surveillance operators - especially those with a 24/7 operating multi-screen setup who are looking for efficient video monitoring. The SC-2402 provides value-added video enhancement controls that help create detailed images for low-light footage. Its optional monitor mounting solutions support single or multiple monitor setups. In terms of cost-to-performance, this model is the solution for productivity in modern operator workstations.





3-Sided Bezel Less Monitor Increase Productivity

It's typical for surveillance operators to require multi-monitor setups to maximize productivity. The SC-2402 adopts a seamless 3-sided bezel-less design to create an ideal work environment and reduce gaps between monitors. Perform rapid analysis, manage, and control video sources from all locations. Evolving situations require quick decisions, which seamless monitors can help with.

Multiple Monitor Setups Made Easy

With VESA 100 x 100mm, the SC-2402 is compatible with AG Neovo's mounting portfolio of desk and wall mounts. Whether you're looking for a dual, quad, or more monitor set-up, AG Neovo is a one-stop-shop for creating ergonomic workstations in a control room.

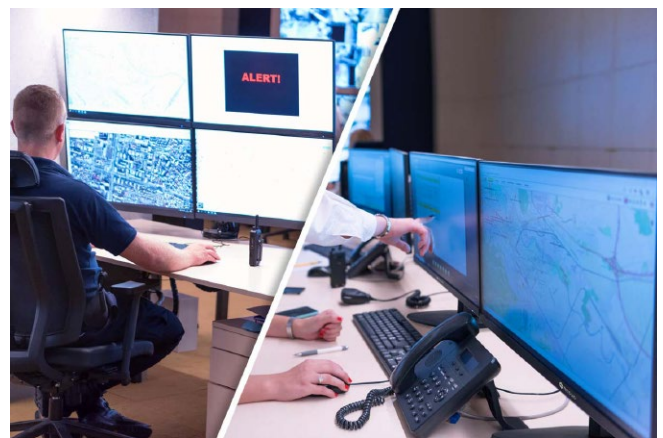

→
(w/o Anti-Burn-in™ Technology)



→
Anti-Burn-in™
→
(w/ Anti-Burn-in™ Technology)



Higher Cost Performance

Designed with long-hour monitoring in mind, you can expect a reduction in system maintenance efforts and consequentially higher cost performance. The SC-2402 is commercial grade and meant to work 24/7, 365 days a year. Static images that would otherwise cause screen burn-in are gone with AG Neovo's patented Anti-Burn-in technology. Expect prolonged life for LCD screens.

Perfect Match to CCTV Images

There is a special pre-configured CCTV Mode that maximises image clarity in low-light footage. Quickly fine-tune your video footage with adjustments for sharpness, saturation, contrast, brightness, and more. Don't waste time testing and re-adjusting constantly, this product already has it all figured out!

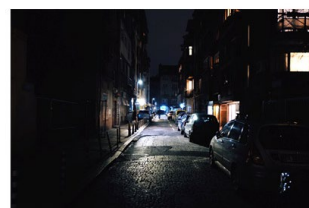

No CCTV Mode

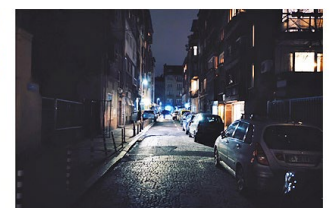

CCTV Mode

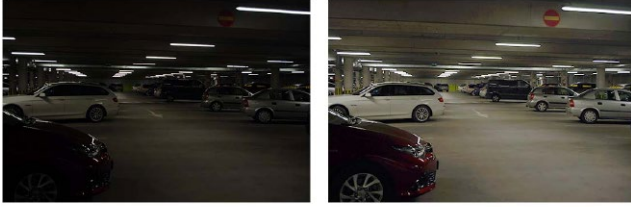

Enhanced Gamma Selection

Offering an enhanced gamma selection makes for amazing visual optimization. Improve the light, shadow, and colour balance quality of your videos with ease.

Missing Details in Dark Scenes is a Thing of the Past

More detail from black-level adjustment means improved visibility of dark images.

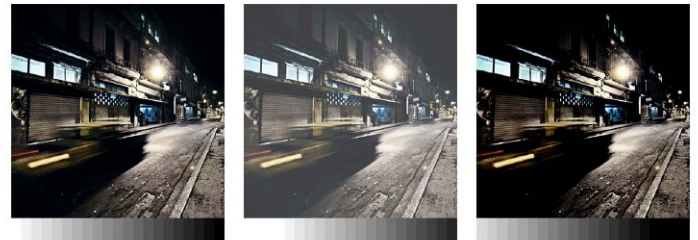

Original Setting

High Setting

Low Setting

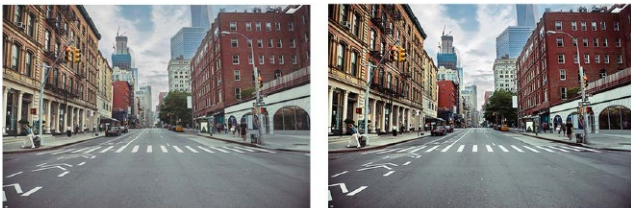

Contrast Enhancer

By coming with a contrast enhancer, the surveillance monitor enables low-contrast images to become more clear and defined.

Adaptable to Surveillance Environment Needs

Tailor the display to your needs with on/off toggles for the blue screen. When there is no signal available, a blue screen will show that is ideally designed for dark and low-light environments.



Versatile Connectivity with BNC and HDMI Inputs

The SC-2402 supports both analog and digital video inputs. Easily connect to various video surveillance equipment with HDMI, VGA and BNC in/out ports. BNC port allows connecting CCTV cameras directly to the monitor. With this bezel less security monitor, there is no need for a DVR/converter to get straight to instant monitoring.

CCTV System with SC-Series BNC Monitors

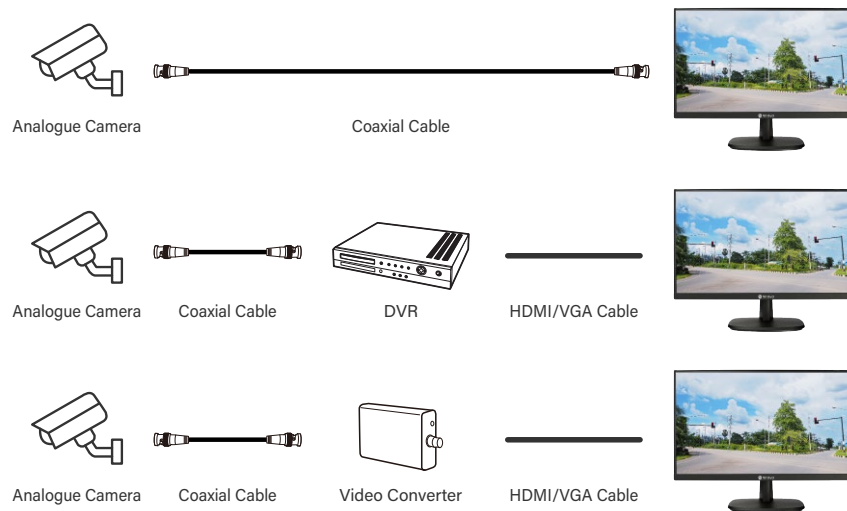

Features

- Anti-Burn-in™ technology prevents image ghosting
- 3-sided narrow bezel design for seamless multi-display setups
- Image Enhancer: 3D Comb Filter / Deinterlace / Noise Reduction
- Versatile connectivity: HDMI, VGA, Composite (BNC)
- BNC passive loop-through output port
- Flicker-free display technology reduces eye discomfort
- Black-level adjustment for presenting more details in dark images
- Selectable gamma curves optimise different kinds of images
- CCTV picture mode for maximum image detail and clarity in low light footage
- Colour engine enhance for colour saturation
- Optional blue or black screen when no input signal is detected
- Designed and developed for continuous 24/7 operation

Specifications

SC-2402

Panel

Panel Type	LED-Backlit TFT LCD (IPS Technology)
Panel Size	23.8"
Max. Resolution	FHD 1920 x 1080
Pixel Pitch	0.275 mm
Brightness	250 cd/m ²
Contrast Ratio	20,000,000:1 (DCR)
Viewing Angle (H/V)	178°/178°
Display Colour	16.7M
Response Time	5 ms
Surface Treatment	Anti-Glare Treatment (Haze25%),3H Hard Coating

Frequency

Frequency (H)	30 kHz-80 kHz
Frequency (V)	56 Hz-75 Hz

Signal Input

HDMI	1.4 x 1
VGA	15-Pin D-Sub x 1
Composite	BNC x 1

Signal Output

Composite	BNC x 1
-----------	---------

Audio

Audio In	Stereo Audio Jack (3.5 mm)
Internal Speakers	3W x 2

Power

Power Requirements	AC 100-240V, 50/60 Hz
On Mode	15W (On)
Standby Mode	< 0.5W
Off Mode	< 0.2W
Power Supply	External

Operating Conditions

Temperature	5°C-35°C (41°F-95°F)
Humidity	20%-85% (non-condensing)

Storage Conditions

Temperature	-20°C-60°C (-4°F-140°F)
Humidity	5%-85% (non-condensing)

Mounting

VESA FPM/PMI	Yes (100 x 100 mm)
--------------	--------------------

Stand

Tilt	-5° to 20°
------	------------

Security

Kensington Security Slot	Yes
--------------------------	-----

Dimensions

Product with Base (W x H x D)	540.1 x 408.3x 226.5 mm (21.3" x 16.1" x 8.9")
Product w/o Base (W x H x D)	540.1 x 303.8 x 41.8 mm (21.3" x 12.0" x 1.7")
Packaging (W x H x D)	606.0 x 480.0 x 108.0 mm (23.9" x 18.9" x 4.3")

Weight

Product w/o Base	3.0 kg (6.6 lb)
Product with Base	3.4 kg (7.5 lb)
Packaging	4.4 kg (9.7 lb)

Regulation Approval

Certifications & Compliance	CE, LVD, WEEE, RoHS, REACH, UKCA, EAC
-----------------------------	---------------------------------------

Accessories

Supplied	Power Cord, VGA Cable, Audio Cable, Quick Start Guide, Warranty Card
----------	--

Optional Accessories

Ceiling Mount (Landscape only)	CMP-01+WMK-03
Wall Mount (Landscape only)	WMA-01, WMK-01, WMK-03, PMK-01
Desk mount (Landscape only)	DMC-01, DMC-02D, DMS-01D, DMS-01Q, ES-02

Global Headquarters

Taipei, Taiwan

EMEA Regional Headquarters

Capelle a/d IJssel, The Netherlands

North & South America Regional Headquarters

San Jose, CA, U.S.A.

Asia-Pacific Regional Headquarters

Taipei, Taiwan

Canada Sales Office

Vancouver, B.C., Canada

China Sales Office

Shanghai, China

Czech Republic Sales Office

Brno, Czech Republic

Denmark Sales Office

Støvring, Denmark

Germany Sales Office

Mechernich, Germany

Italy Sales Office

Livorno, Italy

Poland Sales Office

Warsaw, Poland

Spain Sales Office

Barcelona, Spain

Ukraine Sales Office

Lviv, Ukraine

www.agneovo.com