

Type: Dome Housing & Brackets - Housing & Bracket - Accessories

Item Code: GU-BR-AJX07

EAN CODE: 4260573064021

SMART

The SMART product line offers comprehensive coverage of modern video systems with advanced AI analysis and solutions for various application areas.

Smart Line

In addition to the usual reliability, the SMART product line from GRUNDIG Security offers numerous image analysis functions, supported by artificial intelligence (AI). For example, use the LPR function to recognize license plates or facial recognition to identify people. Or reduce the number of false alarms by classifying objects as 'Vehicle', 'Person' or 'Other'. GRUNDIG Security's SMART cameras are able to detect people in crowds, count the number of heads and measure the length of queues, e.g. B. to be determined in the checkout area. In this way, they help you to use your resources optimally. They also inform you if unauthorized people cross predefined lines or enter certain areas.

Features

- Junction Box for easy installation
- Rugged Aluminium Design

Specifications GU-BR-AJX07

General

Colour: White

Approvals

Regulation: RoHS Compliant

Mechanical

Material: Metal

Dimensions: \varnothing 147 x 67 mm (\varnothing 5.8 x 2.63 inch)

Weight: 310 g (0.68 lb)

Packaging

Package Dimensions: 150 x 150 x 85 mm (5.9 x 5.9 x 3.3 inch)

Package Weight: 400 g (0.9 lbs)

Packaging Unit: 24

Bulk Package Dimensions: 470 x 315 x 360 mm (18.5 x 12.4 x 14.2 inch)

Bulk Package Weight: 10100 g (22.3 lbs)

Accessories



GU-BR-AMP01



GU-BR-AMW01

Dimensions

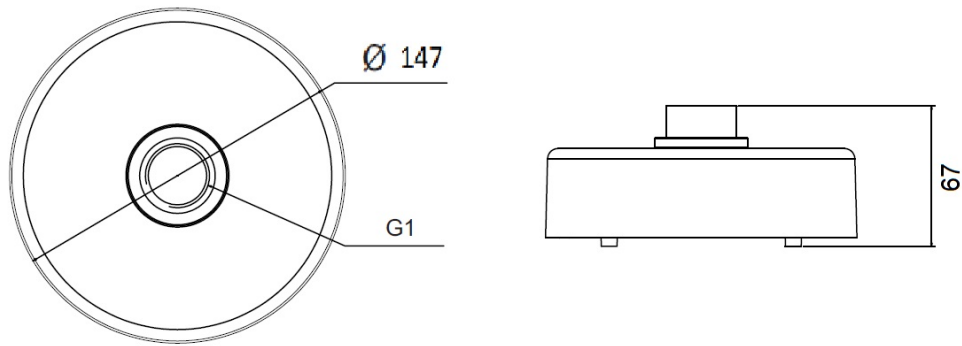

Fits the following products:

GU-CI-AC5637V 5 MP IP-Camera 2.8~12 mm